

Multi-format capability, backlit buttons and straightforward panel layout brings simplicity to operation

SD VIDEO IN Button

Shows both activity and type of input source: no light means no signal being received, red indicates composite and green indicates an S-video source. This enables quick identification of which channels are active and what type of inputs they are. In addition, these buttons can be used as shortcuts in the SD input menu to setup brightness, contrast, saturation and other parameters.

MENU Buttons & Dial

On-Screen display of the setup menu is controlled via this section. The menu is displayed using the SD preview output.

Parameters of Setup Menu

HD/RGB Output	Set format of final output	SD Key	Set Key parameter of SD section
HD/RGB Input	Setup input of HD/RGB section	SD Wipe Select	Wipe setup of SD section
HD/RGB PinP/Zoom	Set PinP parameter of HD/RGB section	Panel Preset Edit	Management of Panel Presets
HD/RGB Key	Set Key parameter of HD/RGB section	Multi Screen	Setup of multi screen mode
HD/RGB Wipe Select	Wipe setup of HD/RGB section	System	System setup of V-440HD
SD Output	Setup of SD PGM output	MIDI Setup	Setup of MIDI parameters
SD Input	Setup input of SD section	Factory Reset	Reset parameters to Factory Preset
SD PinP	Set PinP parameter of SD section		

On Screen Menu Display



HD/RGB IN Button

Automatically detects and shows both activity and type of input source: no light means no signal being received, red indicates RGB and green indicates an HD Component source. This enables quick identification of which channels are active and what type of inputs they are. In addition, these buttons can be used as shortcuts in the HD/RGB input menu to setup brightness, contrast, saturation and other parameters.

OUTPUT FORMAT Buttons

Select output format via these buttons. Specific output format can also be selected via the setup menu.

Output Formats

NTSC	PAL	RGB OUT			
1080i/60i	1080i/50i	1280x1024/60	1024x768/75	800x600/60	
720i/60p	720i/50p	1280x768/75	1024x768/60	640x480/75	
480i/60p	576i/50p	1280x768/60	800x600/75	640x480/60	
480i/60i	576i/50i	1280x768/60	800x600/75	640x480/60	

PANEL PRESETS

Memorize and save up to 15 setups to allow instant, single button recall of any mixer configuration. Menu function allows copying and exchanging presets.

OUTPUT FADE Button

Automatically fade out the master output as set on the TIME dial (0 to 4 seconds). The on, off or fading status is shown via the backlight. Adjust the fade color using the setup menu.

Output Status

Blinking	Fading out
Lit	Output black or white
Turned off	Image from source device is output

PinP & Pan/Zoom

Control of the position, size, pan and zoom of the picture-in-picture window via position joystick and size dial. The LOCK button disables the joystick to secure the position/pan of the window on the screen. PinP within the HD/RGB section can be used with the keyer simultaneously.

Zoom/Pan

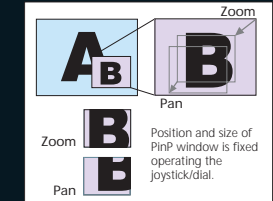

Example of PinP & Keyer

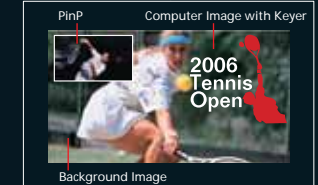

Keyer (HD/RGB)

As with the SD Keyer, composite high resolution images on C-Bus and D-Bus with Chroma Key (blue/green) or Luminance Key (black/white). Key with high resolution images and graphics from computer instead of a dedicated graphic/title generator as a lower cost alternative.

Example of PinP & Keyer

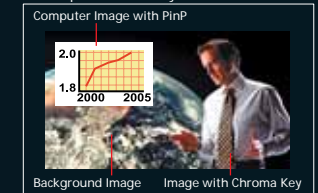

MIDI Button

Turns MIDI input/output on or off. With a touch of a button, enter into synchronization mode controlling multiple units of V-440HD in multi-screen applications.

V-LINK

Control the V-440HD from external, V-LINK enabled Musical Instruments.

PinP Joystick & Dial

Simple control of the position and size of the picture-in-picture window via position joystick and size dial. The LOCK button disables the joystick to secure the position of the window on the screen.

PinP Position Presets

Instant recall of favorite PinP patterns with these simple buttons. Memorize up to five presets.

PinP Setup Parameters

PinP Size	PinP Size
PinP X Position	Horizontal Position of PinP
PinP Y Position	Vertical Position of PinP
PinP Border Size	Border width of PinP
PinP Border Color	Border Color of PinP
PinP Shadow	Shadow width of PinP

Keyer (SD)

Composite images on the A-Bus and B-Bus with Chroma Key (blue/green) or Luminance Key (black/white). Pressing button to turn key function on/off and adjust key level with the dial. Key level is shown numerically on the large LED display and soft edging is available via the menu.

SD Keyer Setup Parameters

SD Key Type	Type of Key composition
SD Key Level	Level of Key composition
SD Key Soft Edge	Level of edge softening (blur)

Up to 4 SD Inputs

Large backlit buttons enable easy and intuitive operation of the 4 S-Video or composite channels. The SD section includes a program output to be used independently if so desired.

SD Channel Select Buttons

Yellow	Channel is selected on current Bus (Program)
Green	Channel is selected on opposite Bus (Preview)
Off	Channel is not selected
Blinking	PinP or Keyer is in use

Transition & Video Fader (SD)

Mix/switch SD section images on the A-Bus and B-Bus with the Video Fader. The AUTO button transits between A-B in the duration specified on the TIME dial. The type of Transition is selectable from Cut, Dissolve (MIX) or wipe (6 patterns). Custom wipe parameters can be saved.

Transitions

CUT	Transit A-B with cut	Transit when video fader reaches center
MIX	Transit with dissolve	Mix images according to fader position
WIPE (1-6)	Transit with wipe	Wipe images according to fader position

Wipe Patterns

Horizontal	Vertical Open
Vertical	Box
Horizontal Open	Cross

Up to 4 HD/RGB Inputs

The HD/RGB section enables mixing and switching of up to 4 inputs from HD video devices (1080i or 720p, HD component) or RGB signals from computer (from VGA to SXGA). The HD/RGB section can be used as an independent mixer or can also take the result of the SD section as an up-converted HD/RGB source.

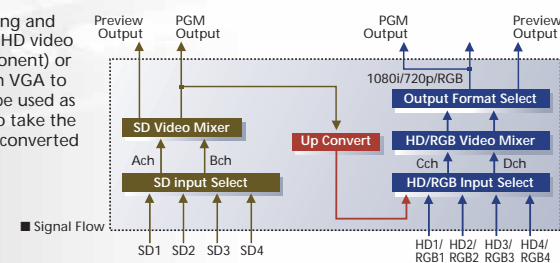

TRANSITION buttons (HD/RGB)

As in the SD section, a variety of transition patterns can be applied with HD/RGB sources. Use SD and HD/RGB transitions simultaneously.

Example of Wipe

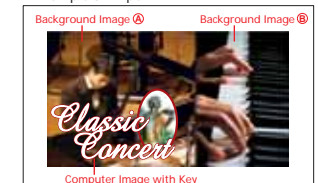

■ HD/RGB Input Section

Up to 4 source devices can be connected via BNC or 15-pin D-sub for direct connection of HD component or computer. For any input, the connectors not being used for the source input can be used as thru output.

■ HD/RGB input parameters

Format Auto Detect	On/Off of input Format Auto Detection	Brightness	Adjust brightness of input image
Input Format	Selection of input format	Contrast	Adjust contrast of input image
Pre Scaling Mode	On/Off of scaling the input image	Saturation	Adjust saturation of input image
Manual Pre Scaling	Manual scaling of the input image	Red	Adjust red level of input image
Scaling Type	Input image method of scaling	Green	Adjust green level of input image
Manual X Scale	Adjust horizontal scaling	Blue	Adjust blue level of input image
Manual Y Scale	Adjust vertical scaling	Frequency	Micro adjust sampling frequency
X Position	Adjust position of horizontal starting point	Phase	Micro adjust sampling phase
Y Position	Adjust position of vertical starting point		

■ SD Output Section

Resultant mix within the SD section is output from the BNC terminal (composite) and S-Video terminal. The SD Preview Output also shows the On-Screen Menu.

■ SD Input Section

Up to 4 SD sources can be connected with BNC terminals (composite) or S-Video terminals. Source signals can be previewed via the Monitor Out BNC terminals.

■ HD/RGB input parameters

SD Input Select	Select S-Video or Composite as priority SD input
SD Brightness	Adjust brightness of input image
SD contrast	Adjust contrast of input image
SD Saturation	Adjust saturation of input image
SD Hue	Adjust hue of input image

■ HD/RGB Output Section

This section contains BNC and D-Sub terminals to output the result of mixing within the HD/RGB section. Preview terminals of BNC and D-Sub are also equipped.

■ NTSC/PAL switching, Test Patterns etc.

Switch between NTSC and PAL modes by pressing button while turning on power. As test patterns, V-440HD can output a 75% color bar or 100% color bar. Other precise setup including brightness, color etc. can also be adjusted.

■ HD/RGB input parameters

Output Format (1080i) Sw	Select format to be assigned on [1080i] button
Output Format (720p) Sw	Select format to be assigned on [720p] button
Output Format (RGB) Sw	Select format to be assigned on [RGB] button
Output Format Lock	Lock Output Format Select buttons
Zooming	Adjust zooming of final output
Bright	Adjust brightness of final output
Contrast	Adjust contrast of final output
Saturation	Adjust saturation of final output
Red	Adjust red level of final output
Green	Adjust green level of final output
Blue	Adjust blue level of final output
Output Fade Mode	Select control mode of Output Fader
Output Fade Color	Select fade color
Test Pattern Select	Output test pattern

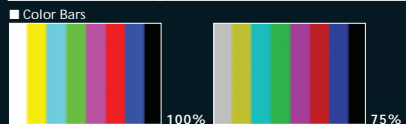

■ TALLY Output Terminals

Two TALLY outputs one for HD/RGB, one for SD that allows selected channel indicators to light when selected.

■ MIDI and REMOTE terminals

V-440HD is equipped with MIDI and REMOTE terminals for controlling from external devices. Video switching, synchronized with music or control from computer software is available with these terminals.

■ Output image to multiple screens from multiple V-440HD units

Connecting multiple V-440HDs via MIDI allows easy setup of multiscreen configurations. The multiple screens are treated as one unified surface with PinP and wipes moving across the screens.

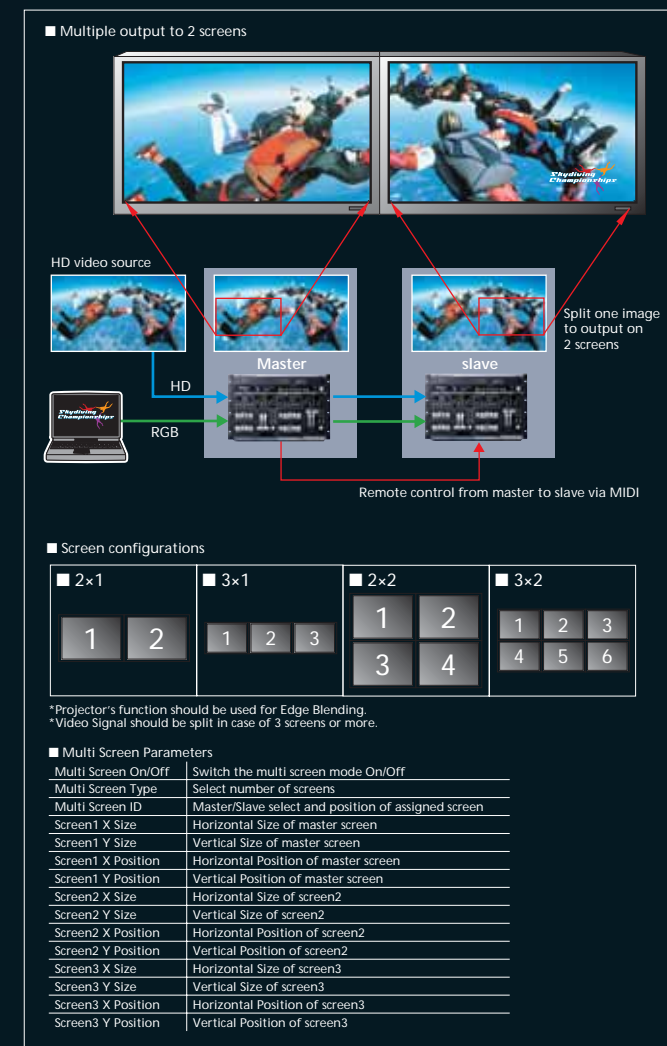

With multi-format capability, the V-440HD can be utilized in various applications.

Live application with multi-cam shooting

With V-440HD, mixing (SD and HD) live sources is possible without any external converters. In addition, VCR and computer for background image and name/title insertion is achievable.

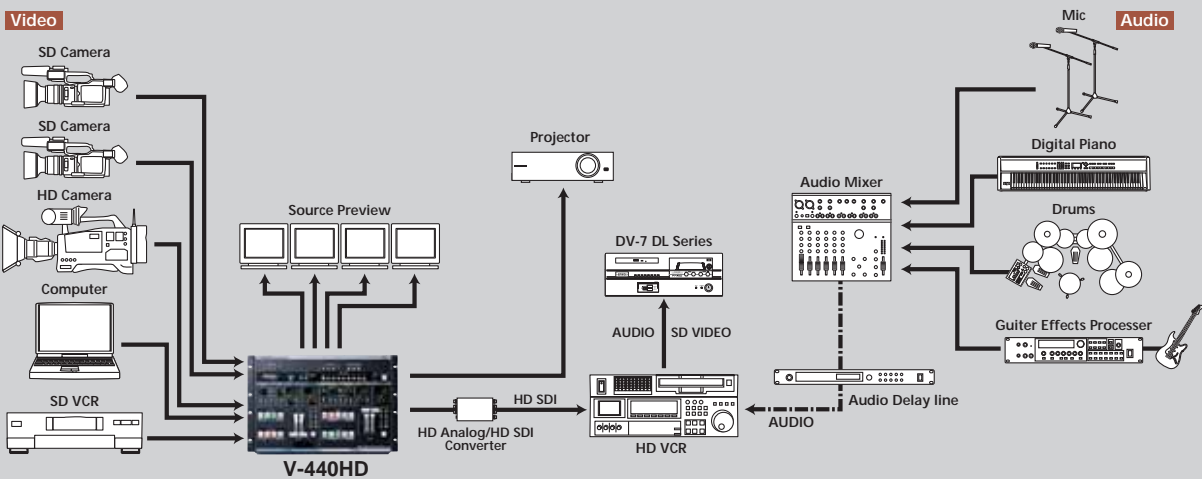

Installation application with various sources

With the V-440HD, capable of inputs from various sources and output to various devices — full freedom is achieved.

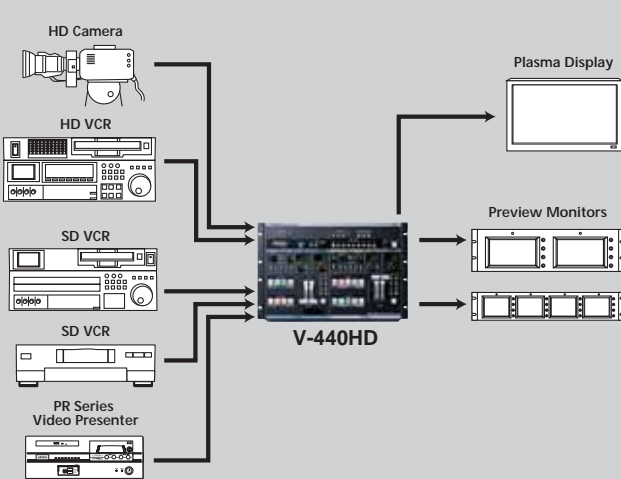

■ Version 2.0 software for the V-440HD Multi-Format Video Mixer adds 20 new features that provide additional operational benefits.

Flip Flop mode allows your choice of switching style



Select the input channel you would like to cue on PST side. The image is output on the Preview monitor. Just press AUTO button to send the signal to Program output. Version 2.0 software can disable the input selector where no input signal is detected.

Choose from a variety of colors to backlight the LED input buttons.

Auto detection of RGB input format and wider variation of RGB outputs. The RGB inputs formats are detected automatically. This enables rapid replacement of multiple computers to one input. 1366x 768 (WXGA) resolution is now supported as an output format enabling high quality native support of most mid-sized LCD panels.

Expansion of Menu and Panel Preset functions Recall the default value of each and every parameter. Convenient for instant recall of input parameter, color settings etc. Double-click any button for instant selection of related menu. Fade to black between memory presets.

Further expansion of PinP and Fade Operation

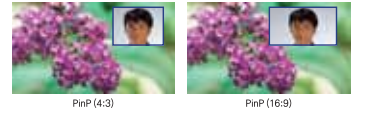

The aspect ratio for a PinP image (HD/RGB) can be set regardless of the aspect ratio of the source image. Master output fade function can optionally effect the SD output as well.

Unifies multiple types of inputs into a single output.
Extremely smooth and intuitive operation.
Highly precise Input/Output setup and Effects.
The video mixer for a new generation of users.

MULTI-FORMAT VIDEO MIXER
V-440HD Ver. 2.0
V-LINK

With capability to input 4 SD video sources and 4 HD or RGB video sources, the V-440HD enables seamless mixing and switching of multi-format video signals. With a single unit allowing images with different aspect ratios (16:9 or 4:3)*, the V-440HD can also be used as an independent SD mixer or HD/RGB mixer. Add various effects like PinP, 2 Keyers or transitions and it's easy to see how this unit becomes the center of all your multi-format video production.

Finally an affordable video mixer for the foundation of

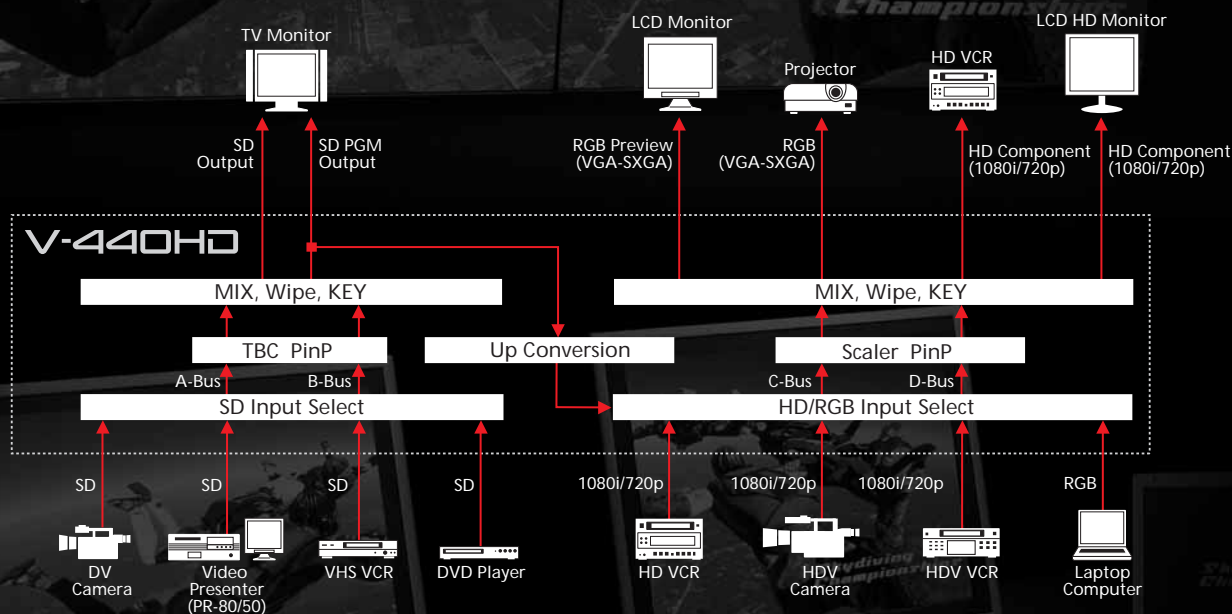

your multi-format video production.

* The SD section will allow one aspect (4:3 or 16:9) at one time.

Broadcast Engineering's
2005 Pick Hit Award



For over 21 years *Pick Hit* awards have been selected by industry professionals. Each year they are awarded to only 20 products chosen from the thousands of products shown at NAB. *Pick Hit* winners are selected because of their positive impact on the everyday work of the intended user, their technological improvement over previous products, and their appropriateness in pricing.

SPECIFICATIONS

Video Processing	
Video Format	SD: NTSC or PAL (CVBS, S(Y/C)) HD: 1080/59.94i/50i SMPTE274M (Y:Pb:Pr TriLevel Sync) 720/59.94p/50p SMPTE296M (Y:Pb:Pr TriLevel Sync) RGB: 640x480/60/75, 800x600/60/75, 1024x768/60/75, 1280x768/60/75, 1280x1024/60 1366x768/60 (RGB VH:positive/negative logic) *VESA DMT Version 1.0 Revision 10 conform
Video Sampling	SD: 4:2:2 (Y:B-Y:R-Y), 8-bit, 13.5 MHz (BT.601) HD: 4:4:4 (Y:Cb:Cr), 8-bit, 74.1758 MHz/74.25 MHz/000 RGB: 4:4:4 (R:G:B), 8-bit, 25 MHz to 110 MHz
Video Transition	Cut, Dissolve(MIX), Wipe : 6 Patterns, Reverse, SoftEdge, OneWay
Video Effects	Composition FX Picture in Picture, Chroma Key (Blue/Green), Luminance Key(White/Black) Picture in Picture with Zoom/Pan (HD/RGB side only)
Functions	
Multi-Screen Presentation	Screen Setup : 2 screens x 1 line, 3 screens x 1 line, 2 screens x 2 lines, 3 screens x 2 lines
Synchronization of Multiple Units by MIDI	Control the slave unit(s) from master unit
Master Fade	Auto (0 to 4 seconds) or Manual Black or White
Others	
Power Supply	AC 117 V, AC 230 V, AC 240 V (50/60 Hz), AC 220 V (60 Hz)
Power Consumption	50W
Dimensions	482(W) x 308(D) x 130(H)mm or 19(W) x 12-1/8(D) x 5-1/8(H) inch *EIA-7U Rack Mount Size
Weight	6.8 kg or 15 lbs

Connectors	
SD Input	S-Video (Y/C) Preferential x 4:4-pin mini DIN type (Y:1.0 Vp-p, C:0.286 Vp-p, 75 ohms) Video (composite) x 4:BNC type (1.0 Vp-p, 75 ohms)
HD/RGB Input	BNC Type x 4 HD: Y/Pb/Pr (1.0Vp-p, 75Ω, TriLevel Sync) RGB: R/G/B (0.7Vp-p, 75Ω), H (5VTTL), V (5VTTL) D-SUB 15pin Shrink Type for HD/RGBx 4 *For In or ThruOut use, select BNC Type or D-sub Type
SD Output	PGM S-Video (Y/C): 4-pin mini DIN type (Y:1.0 Vp-p, C:0.286 Vp-p, 75 ohms) Preview: BNC type (1.0 Vp-p, 75 ohms), OSD Menu Output
HD Output	PGM Component HD: BNC Type x2 (1.0Vp-p, 75 ohms, TriLevel Sync) *Select Component or RGB output Preview Component HD: BNC type (1.0 Vp-p, 75 ohms, TriLevel Sync) OSD Menu Output (display On/Off is selectable)
RGB Output	PGM RGB: D-sub 15pin Shrink Type x2 (0.7Vp-p, 75 ohms, 5VTTL Sync) *Select Component or RGB output Preview RGB: D-sub 15pin Shrink type (0.7 Vp-p, 75 ohms, 5VTTL Sync) OSD Menu Output (display On/Off is selectable)
Remote Control Interfaces	MIDI 5pin DIN Type (In, Out/Thru), RS-232C D-sub 9pin
TALLY Output	D-sub 15pin Shrink type x2 (1 for SD/1 for HD) Max Input : 12V, 200mA Open collector Type
Signal Latency	SD Input - SD Output: 1 frame SD Input - HD/RGB Output: 2 frames HD/RGB Input - HD/RGB Output: 1 frame

Dimension Chart (mm)

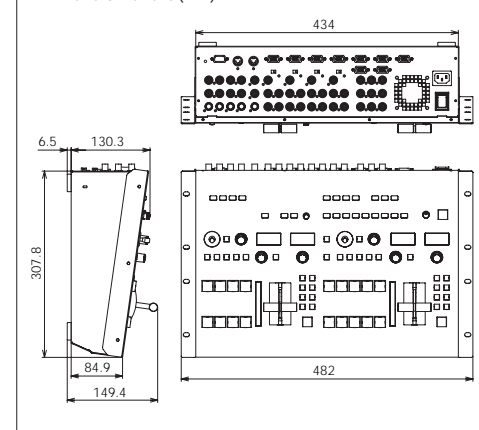

Block Diagram

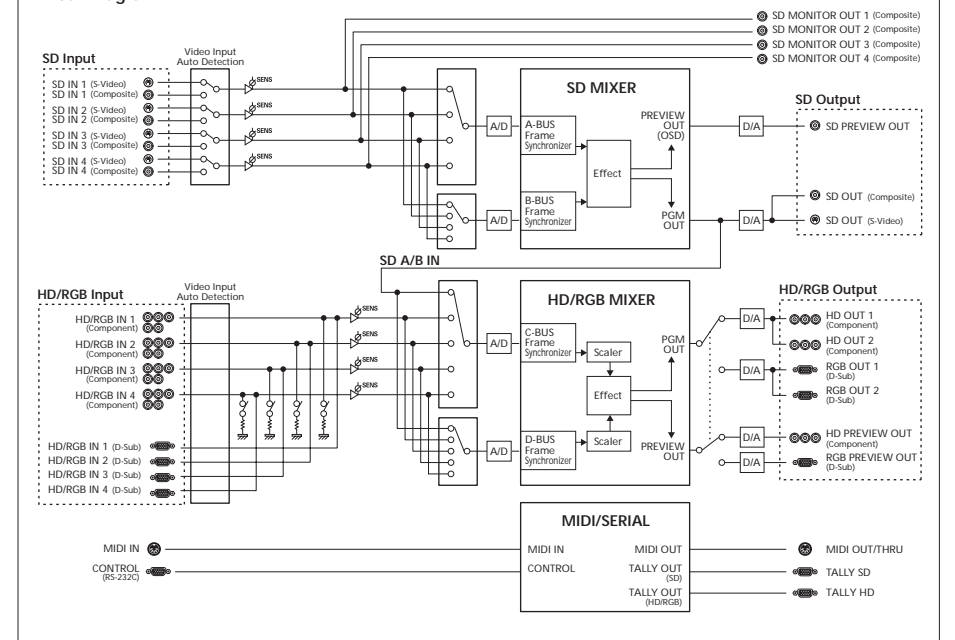

Get More of the Story Online
www.edirol.com/v440hd
800.380.2580



EDIROL
by Roland

Roland
Systems Group

Copyright 2007 Roland Corporation. All right reserved
All specification and appearances are subject to change without notice
June 2007 RSG-U.S.



EDIROL
by Roland

*Seamless mixing of
HD, SD and PC-RGB
video signals*



MULTI-FORMAT VIDEO MIXER

V-440HD Ver. 2.0



Pick Hit Award From
Broadcast Engineering Magazine
at NAB 2005

MULTI-FORMAT VIDEO MIXER
V-440HD

Mix Multiple Input Formats

Capable of mixing HD (1080i/720p:component), SD (S-Video, Composite) or RGB from computer (from VGA to SXGA).

Choose from Various Output Formats

Output format is selectable from various types: 1080i or 720p for HDTV and RGB for computer displays. SD inputs are up-converted but can also be output independently.



Switch and Mix Seamlessly

Totally seamless mixing and switching is a reality with high quality up conversion, scan conversion as well as built-in TBC/frame synchronizer.

Simple and intuitive operation

With active input channel indicators, backlit channel buttons, single touch recall presets, joystick and dial control of PinP and Keys — operation is simple and intuitive.

Synchronize Multiple Units and Control Remotely

With thru outputs and MIDI, multiple units can be cascaded to drive multiple screens (video walls). Control the V-440HD remotely via MIDI, V-LINK or RS-232C.